

FOREWORD

This section must be read before any connection is made to the mains supply.

WARNINGS

Do not expose the equipment to rain or moisture.
 Do not remove the cover from the equipment.
 Do not push anything inside the equipment through the ventilation holes.
 Do not handle the mains lead with wet hands.

EQUIPMENT MAINS WORKING SETTING

Your Marantz product has been prepared to comply with the household power and safety requirements that exist in your area.

This product can be powered by 120 V AC only.

COPYRIGHT

Recording and playback of any material may require consent. For further information refer to the following:

Copyright Act 1956
 Dramatic and Musical Performers Act 1958
 Performers Protection Acts 1963 and 1972
 any subsequent statutory enactments and orders

ABOUT THIS USER GUIDE

Refer to the Figures on the page 10 at the rear of this user guide. The numbers on the diagrams correspond to those in the text. All references to the connections and controls that are printed in BOLD type are as they appear on the unit.

PRECAUTIONS

The following precautions should be taken when operating the equipment.

GENERAL PRECAUTIONS

When setting the equipment ensure that:

- the ventilation holes are not covered
- air is allowed to circulate freely around the equipment
- it is on a vibration free-surface
- it will not be exposed to interference from an external source
- it will not be exposed to excessive heat, cold, moisture or dust
- it will not be exposed to direct sunlight
- it will not be exposed to electrostatic discharges

Never place heavy objects on the equipment.

If a foreign body or water does enter the equipment, contact your nearest dealer or service centre.

Do not pull out the plug by pulling on the mains lead, hold the plug.

It is advisable when leaving the house, or during a thunderstorm, to disconnect the equipment from the mains supply.

SM-17SA

The SM-17SA is a power amp that can be switched between stereo and monaural operation (BTL operation). In addition, the SM-17SA is equipped with a line amp that is compatible with fast BTL amps. This capability makes an even more advanced audio system possible by allowing you to connect another power amp to your system so that you can implement bi-amp drive for the speaker system.

CONNECTIONS

The connection method illustrated below is used when the SM-17SA is being used as a stereo power amp. For details on other connection methods, refer to the examples on the following page.

MRANTZ PM-17SA Integrated-amp
or other pre-amp

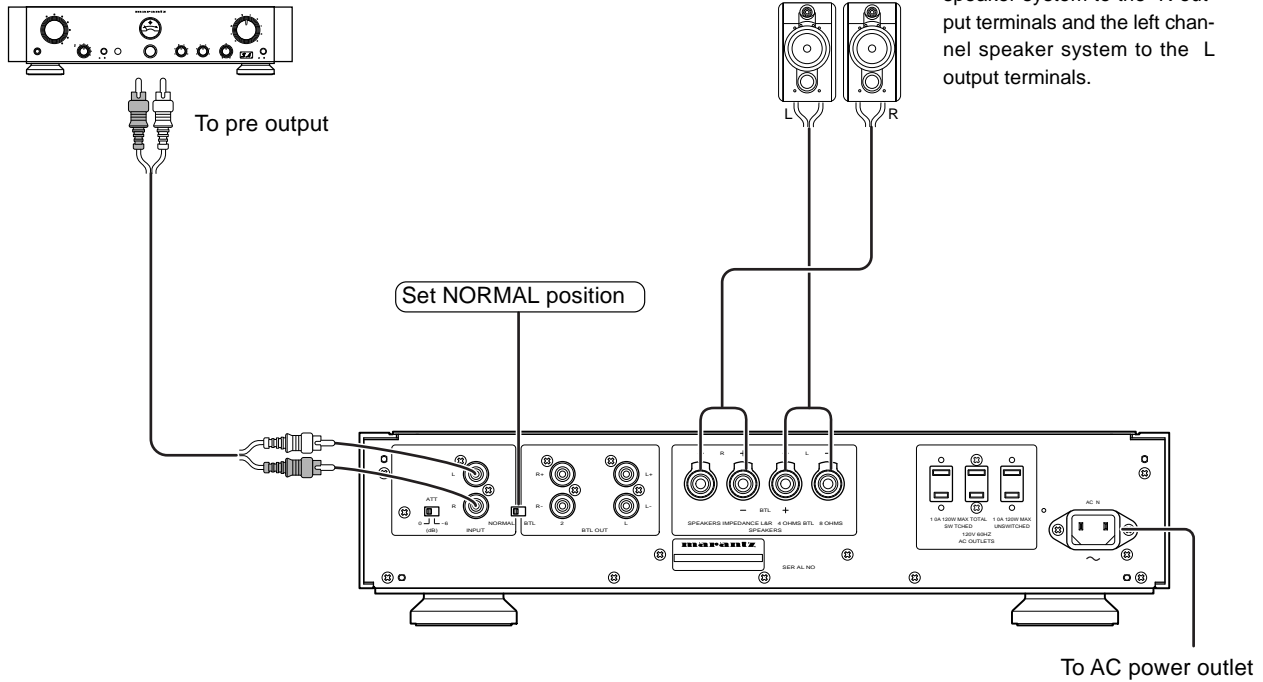

Speaker system

Connect the right channel speaker system to the R output terminals and the left channel speaker system to the L output terminals.

CONNECTIONS OF AMPLIFIER

Connect the output jacks of your pre amplifier to the INPUT jacks

Connection of speaker systems

Each of the speaker systems connected to this unit should have a impedance between 4 and 16 ohm. Connecting a speaker system with a lower impedance than 4 ohm may activate the protection circuitry during sound reproduction.

The output terminals are provided with the positive (+ :Red) and negative (- : White) polarity, and the input terminal of each speaker system also has the polarity (+ and -). Be sure to connect the terminals with the identical polarity.

Caution:

If you will be using two speaker systems, or you will be using the SM-17SA in BTL mode, use speaker systems that have an impedance of at least 8 ohm. If you connect a speaker system that has an impedance of less than 8 ohm, the SM-17SA's protective circuitry may be worked, making the amplifier incapable of normal stereo playback.

Connection of speaker cord

 Strip coating from extermity.

 Twist conductors.

Speaker cord

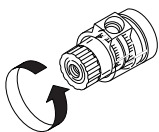

Turn counterclockwise to loosen.

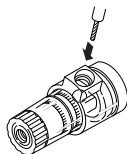

Insert conductors.

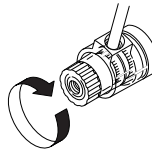

Turn clockwise to tighten.

EXAMPLES OF USAGE

The examples shown below illustrate a Marantz PM-17SA (pre-main amp) and an SM-17SA being used in combination for bi-amp drive of a speaker system that is compatible with bi-wiring.

Example 1: Bi-amp connection with a PM-17SA + SM-17SA

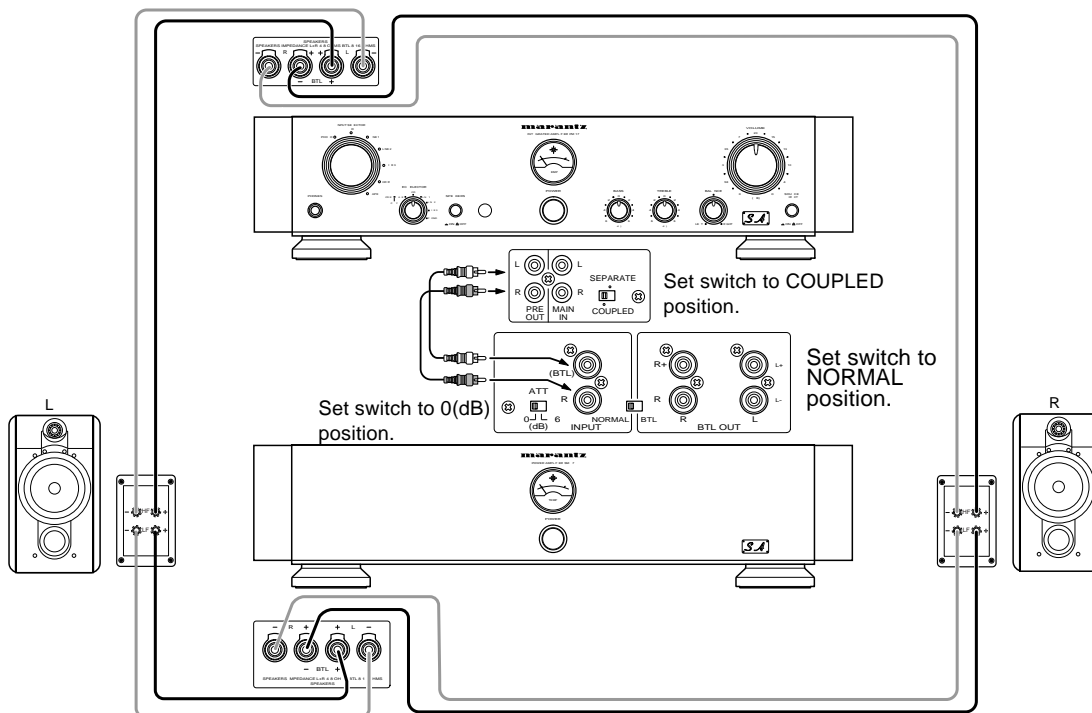

Example 2: Bi-amp connection with a PM-17SA + two SM-17SAs

This example uses two SM-17s, each in BTL operation mode. This setup can powerfully drive the speaker systems bass driver unit.

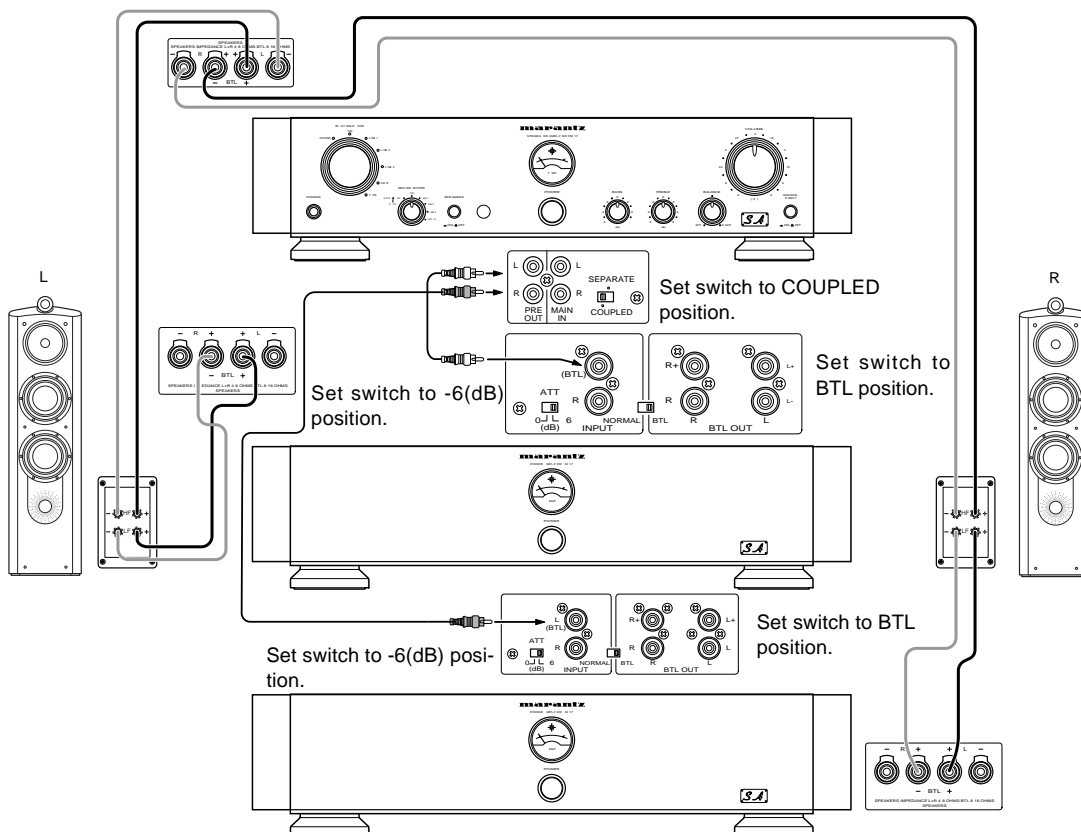

Caution concerning Bi-amp Connection

Some speaker systems that permit bi-wiring do not permit bi-amp connection as described in the example on the preceding page. For example, if the \oplus or \ominus speaker terminals used for bi-wiring are shared, bi-amp connection is not possible with that speaker system.

(The system will not operate correctly because the amp's protective circuits will be worked, etc.)

For details, refer to the user guide provided with the speaker system, or contact the manufacturer of the speaker system.

NAMES OF CONTROLS AND INDICATORS

(Page 10)

A ATT switch

The gain of the amp increases during BTL operation in comparison with normal stereo operation.

The ATT switch is an attenuator switch that reduces the amp gain by 6dB so that the gain is same with the gain that is output during normal stereo operation.

B INPUT jack

The L(BTL)/R input jacks are the left/right signal input jacks. When using the amp as a BTL amp (monaural), input the signal to the L(BTL) input jack.

During BTL operation, this jack also functions as the BTL line amp signal input jack.

C BTL switch

When this switch is in the NORMAL position, the unit functions as a stereo power amp.

When this switch is in the BTL position, the unit functions as a monaural power amp.

Caution:

The BTL circuit (Balanced Transformerless circuit) can amplify the output power by having two amps connected to each other through a bridge connection; this amp will then function as a monaural amp. In addition, when this switch is in the BTL position, the signal from each amp is output to their corresponding BTL output jack (BTL OUT).

D BTL OUTPUT jack

These are the BTL line amp output jacks. The signal is output on these jacks if C BTL switch is set to the BTL position.

A signal with the same phase as the signal that was input to the L(BTL)/R input jacks is output on the L+/R+ output jacks, and a signal with the inverted phase as the signal that was input to the L(BTL)/R input jacks is output on the L-/R- output jacks.

If another stereo power amp is connected, it can be used as a BTL power amp (monaural).

(Do not connect any power amp for which the BTL connection is not guaranteed.)

E SPEAKER OUTPUT terminal

These output terminals are for connecting the speaker systems.

Refer to page 2 for details on how to connect the speaker system when using the SM-17 as a stereo power amp.

When using the SM-17 as a BTL amp (monaural), connect the speaker system to the L \oplus terminal and the R \oplus terminal. In this case, connect the positive line from the speaker system to the BTL \oplus (L \oplus) terminal, and the negative line from the speaker system to the BTL \ominus (R \oplus) terminal.

F AC IN jack

Connect to AC power outlet.

This unit can be powered by 120 V AC only.

G AC OUTLETS

[SWITCHED]

The switched outlet is turned on and off by the main power switch. The maximum power capacity of this outlet is 120W.

[UNSWITCHED]

Use this outlet as the power supply for a component that does not need to be turned on and off by the main power switch. The maximum power capacity of this outlet is 120W.

Do not plug a device that consumes a great deal of power into this outlet.

For the best audio quality, we recommend that you plug your CD player, MD player, or other digital audio component into a power outlet that is independent of the power supply for the amp.

① POWER switch

Press to turn power ON and press again to turn it OFF.

Meter ② lights up when the POWER is turned ON.

② Warm-up meter

With any audio unit, the real sound quality cannot be obtained immediately after the power is turned on, and warming up is required to make the unit exhibit its full performance. As time passes after the power has been turned ON, the temperatures of different parts of the unit become constant and the electrolytic capacitors become active.

This meter allows to check the warm-up condition of the unit. The meter needle starts to swing gradually in a little while after the power is turned ON and reaches about 2/3 of the meter's full scale in about 30 minutes. Now the unit has almost been warmed up and can reproduce music with its original performance.

The meter positions immediately after turning power on and at the end of warming up and the time taken for warming up are variable depending on the temperature, ventilation and other conditions of the listening room where the unit is located.

TROUBLESHOOTING

In case of trouble with the unit, first check the following before calling for service. What seems to be a serious malfunction is often due to a simple operation mistake.

If the trouble still persists after checking, please consult your dealer or nearest MARANTZ service agent.

The amplifier does not work and the warm-up meter lamp does not light.

1. Check if the power cord is plugged properly into an AC power outlet.

Sound is produced only from one of the speaker systems.

1. Check the connection of the RCA pin cords and speaker cords.
2. Turn power of the set off and change the connections of the left and right speaker systems. If sound is still not output from the same speaker system, check its connection cord or the speaker system itself.

Sound is not produced at all.

1. Check the connection of the speaker cords.
2. Check the connection of the RCA pin cords.

The sound from both speakers is monaural.

1. Make sure that the NORMAL/BTL switch is not set to the BTL position.

TECHNICAL SPECIFICATIONS (DIN)

Rated power output (20 Hz to 20 kHz 2 CH simultaneous drive)	60W x 2 (8 Ω load)
	80W x 2 (6 Ω load)
	100W x 2 (4 Ω load)
(20 Hz to 20 kHz BTL drive)	200W x 1 (8 Ω load)
Total harmonic distortion (20 Hz to 20 kHz 2 CH drive, 8 Ω load)	0.01 %
Cross-modulation distortion (SMPTE)	0.01 %
Output bandwidth (8 Ω load 0.04 %)	10 Hz to 50 kHz
Frequency response	5 Hz to 100 kHz +0, -1 dB
Damping factor (8 Ω load, 20Hz to 20kHz)	100
Input sensitivity/input impedance	1.6 V/22 k Ω
S/N (IHF network, input shorted)	112dB
Supply voltage	120 V AC, 60 Hz
Power consumption	180 W
Dimensions	
Width	458 mm
Height	110 mm
Depth	407mm
Weight	15.5 kg

Design and specifications are subject to change without notice.

